

G4WPW

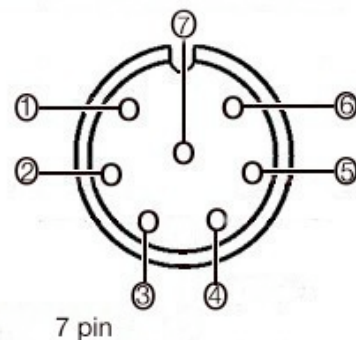

TRANCEIVER INFORMATION LIST

POPULAR MICROPHONE PLUG AND SOCKET PINOUTS.

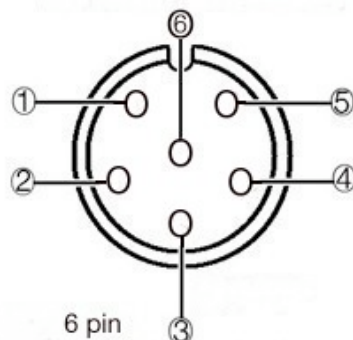
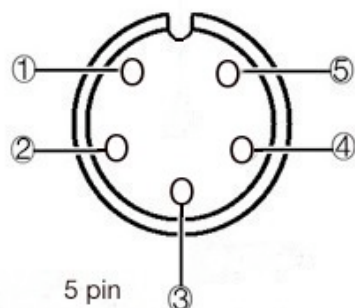

view from front of transceivers

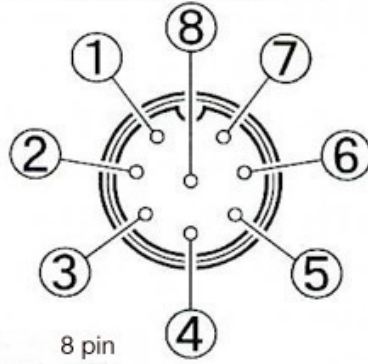

diagrams g4wpw

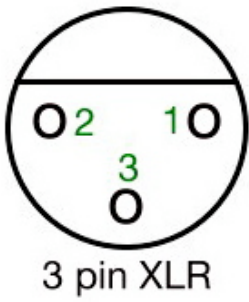
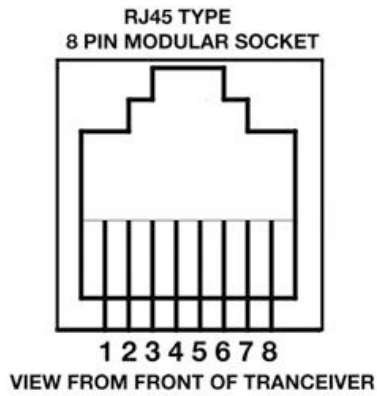
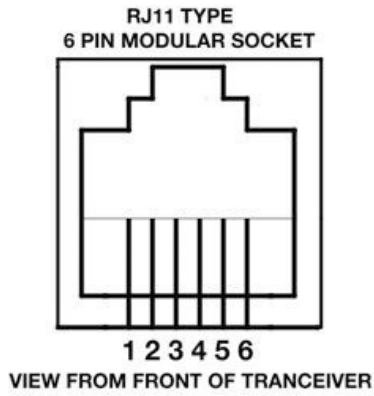

XLR Plugs

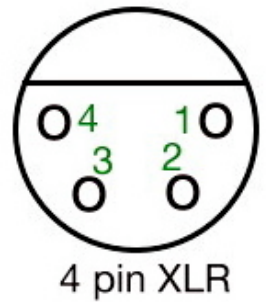

X=(cannon x) L=(Latch) R=(rubber compound)

TRIO/KENWOOD.

Kenwood Most popular connections

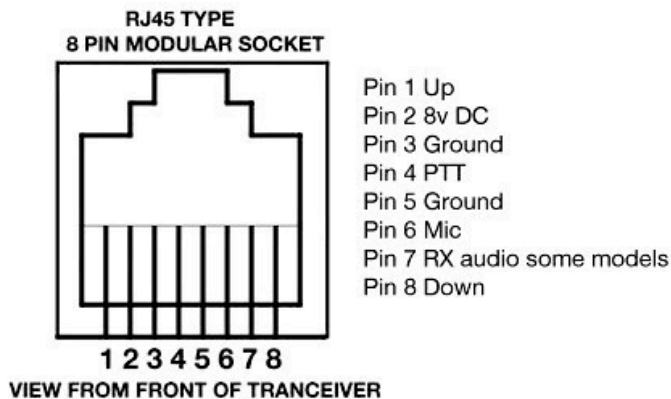
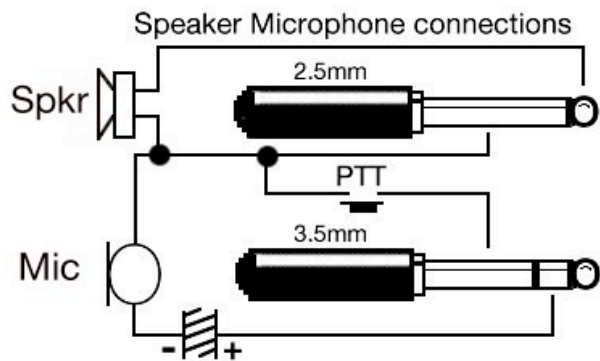

VIEW FROM FRONT OF TRANCEIVER

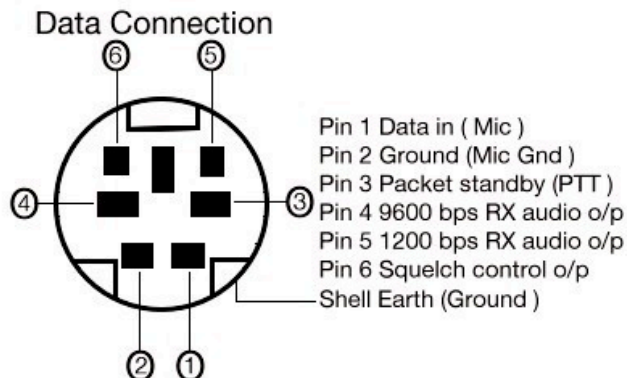
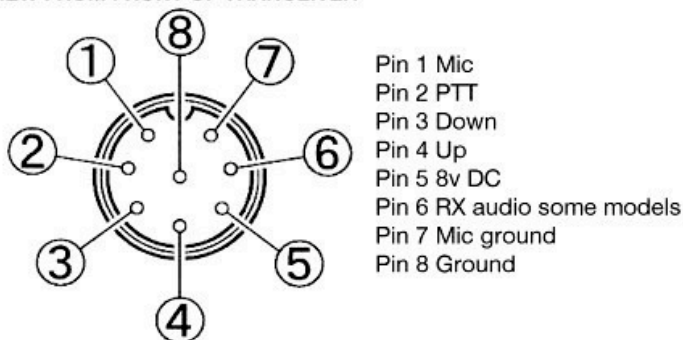

diagrams g4wpw

KENWOOD(Handheld Tranceiver's)-TH-22A/AE TH-42A/AE TH-78A/E TH-F6 TH-F7 TH-F7E THG-71 TH-D7A/E TH-K2AT TH-K2E TH-K4E TH-K4AT TH-235 UBZ-LJ8BE UBZ-LJ8SLE UBZ-LJ8YE VBZ-LH14 VBZ-LF AR-14 GR-14
 (see [SMC-32](#) [SMC-33](#) [SMC-34](#) above for external microphone and PC interconnection)

KENWOOD(Handheld Tranceiver's)-TR-2500 TR-2600

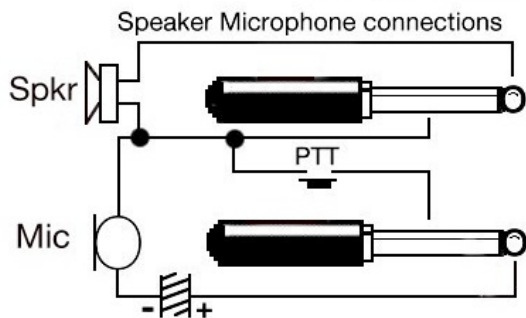

(see [SMC-25](#)/[SMC-30](#) above.)

KENWOOD-T599S-TS120S-120V-700G-700S-130S-130V-490-520S-530S-820S-830S-

TR2300-TR2200-TR2200GX-TR3200-TR7010-TR7200-TR7200G-TR7400A-TR7500-TR7600-TR7625

PIN1	MIC
PIN2	PTT
PIN3	PTT/EARTH
PIN4	SCREEN AND EARTH



7 PIN REMOTE PLUG/SOCKET.

KENWOOD-TS120-130-140-180-430-440-450-530-570-680-690-830-870-940-950.

PIN1	SPEAKER OUT
PIN2	RELAY COMMON GROUND/EARTH
PIN3	PTT FOR FOOT SWITCH
PIN4	RELAY CLOSED ON TRANSMIT
PIN5	RELAY OPEN ON TRANSMIT
PIN6	ALC INPUT
PIN7	+12VOLTS ON TRANSMIT (10 Ma Max)
PLUG	SHELL EARTH.

6 PIN ACC PLUG/SOCKET.

KENWOOD-TS-450-690-570-850-870-950.

PIN1	SIGNAL GROUND/EARTH
PIN2	TRANSMIT DATA
PIN3	RECEIVE DATA
PIN4	CTS ENABLE TX
PIN5	RTS ENABLE RX
PIN6	N/C
SHELL	EARTH

13 PIN ACC2 PLUG.

KENWOOD-TS440-450-680-690-570-711-790-811-850-870-940-950

PIN1	N/C
PIN2	N/C
PIN3	RX AUDIO OUT
PIN4	SCREEN FOR PIN3
PIN5	SQUELCH CONTROL OR N/C
PIN6	S/METER OUTPUT
PIN7	N/C
PIN8	CHASSIS/GROUND
PIN9	PTT- STANDARD MIC INPUT IS MUTED
PIN10	N/C
PIN11	MIC INPUT
PIN12	SCREEN FOR PIN 11
PIN13	PTT- STANDARD MIC INPUT IS ACTIVE
SHELL	EARTH

KENWOOD-TR9000-9030-9130-9300-9500-7700-7730-7750-7800-7850-7930-7950-8400

PIN1	MIC
PIN2	PTT
PIN3	DOWN
PIN6/CENTER	EARTH
PIN4	UP
PIN5	NC + 8VOLT SOME MODELS

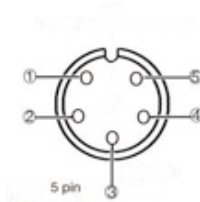

KENWOOD-TR7600-TR7625

PIN1	MIC
PIN2	PTT
PIN3	N/C
PIN4	CHASSIS/GROUND
PIN5	MIC SCREEN

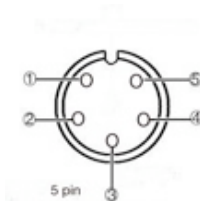

KENWOOD-TS480 (8 Pin modular Plug)

PIN1	UP
PIN2	+8 VOLTS
PIN3	GND
PIN4	PTT
PIN5	MIC GND
PIN6	MIC
PIN7	N/C
PIN8	DOWN

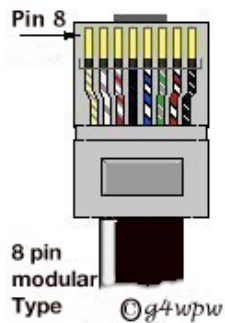

UPDATE.

Some errors in the TS-480 schematics leading to RF feedback when using other than the stock microphone have been noted by Kenwood, if this problem is experienced reverse the connections to pin3 and pin5.

KENWOOD-TS-50-60-140-430-440-450-570-660-670-780-930-430-670-711 TS-811-850-870-930-940-950-440-701-790-680-690-TS-2000
 TR-3200-7900-7950-50-751-851
 TM-201A-201B-401A-TM401B-211-221-231-241-321-331-3530-421-431-441-521-531-541
 TM-621-631-701-721-731-2530-2550-2570
 TW4000-4100

PIN1	MIC
PIN2	PTT

PIN3	DOWN
PIN4	UP
PIN5	+ 8VOLT Some models (10 Ma)
PIN6	(N/C Some models)
PIN7	MIC GROUND.
PIN8	GROUND (STBY)

view from front of transceivers



KENWOOD-TM-251-255-261-271-271E-451-455-461-641-642-708-732-733-741-742-941-942 (8 Pin modular Plug)
 TMG-707 TMD-700 TMD700A TMV-71A.TMV-71E-V7A.

KENWOOD PMR TRANCEIVER MODELS-TK-90-7108HM-7108M-7160E-7160HM-7160M-7162E-7180E-7189E
 8108HM-8108M-8160E-8160M-8162E-8180E-8189-TK90 (see KMC-30 /32 /35 above)

PIN1	UP
PIN2	+8 VOLTS (100ma max)
PIN3	GND
PIN4	PTT
PIN5	MIC GND
PIN6	MIC
PIN7	N/C. RX AUDIO (some models)
PIN8	DOWN

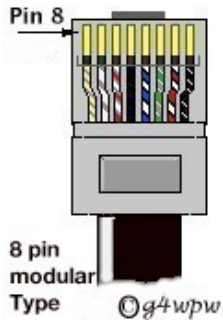

KENWOOD-TM-271A (8 Pin modular Plug)

PIN1	N/C
PIN2	+8 VOLTS (100ma max)
PIN3	GND
PIN4	PTT
PIN5	MIC GND
PIN6	MIC (600 ohm impedance)
PIN7	N/C
PIN8	KEYPAD SERIAL DATA.

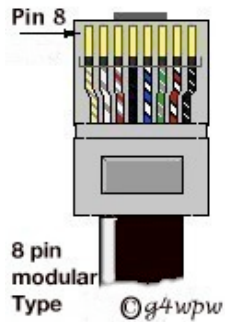

YAESU.

YAESU (Handheld Tranceiver's) VX-1R VXF-1 VX-2R VX-2E VX-3R VX-5R VX-10 VXF-10 VX-110 VX-130 VX-131 VX-132 VX-150 VX-160 VX-180 VX-210 VX-210A VX-300 VX-400 VX-410 VX-420

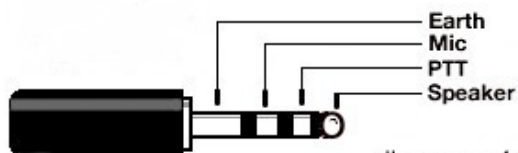

diagram g4wpw [SEE MH34 ABOVE](#)

YAESU (Handheld Tranceiver's) FT-10R FT-40R FT-50R FT-60R

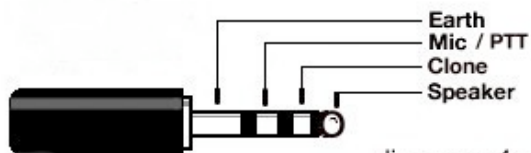
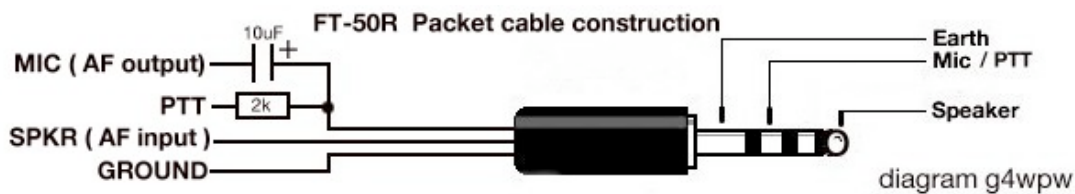
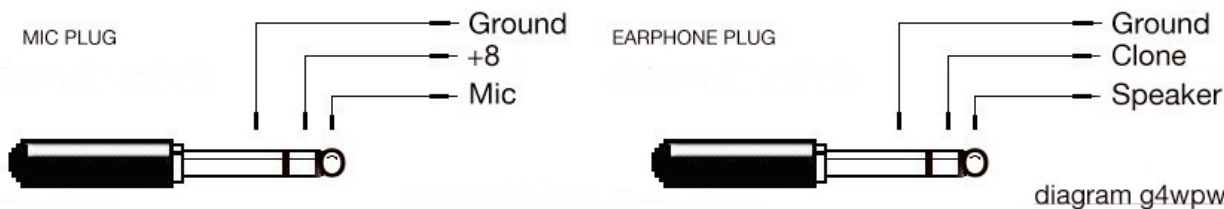

diagram g4wpw [SEE MH-37A4B ABOVE](#)

YAESU FT-50R FT-60R



YAESU (Handheld Tranceiver's) FT-51R



YAESU (Handheld Tranceiver's) FT-23R FT-73R FT-470 FT-411 FT-811 FT-911

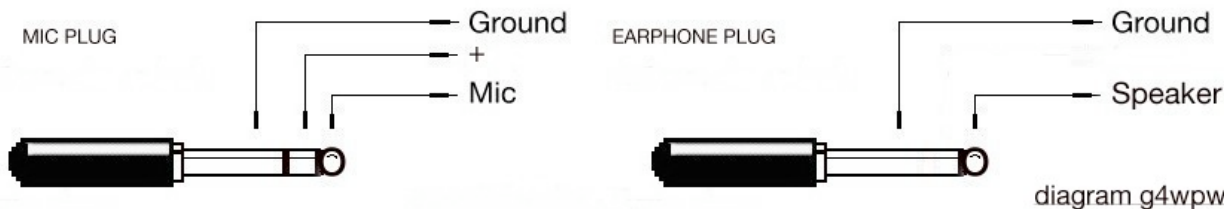

YAESU (Handheld Tranceiver's) FT-530

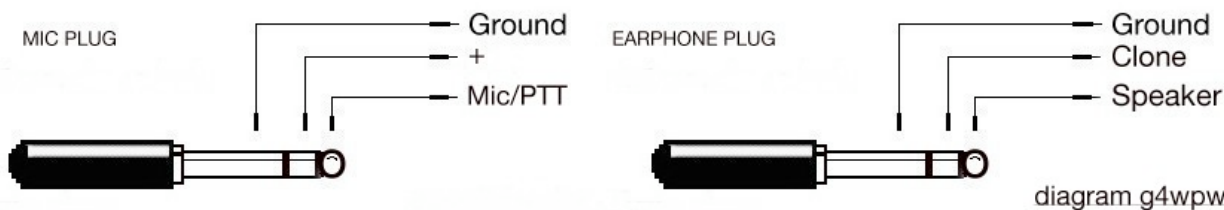

YAESU POLICE AND PUBLIC SAFETY CHANNELISED TRANCEIVERS

VX-2000 VX-2500 VX-3000 VX-3200 VX-4100 VX-4100E VX-4200 VX-4200E VXR-1000 VXR-7000

(See MH-25A8J and MD-11A8J microphones above)

PIN1	FAST
PIN2	GROUND
PIN3	PTT
PIN4	MIC
PIN5	MIC EARTH
PIN6	+ 5VOLTS
PIN7	UP
PIN8	DOWN

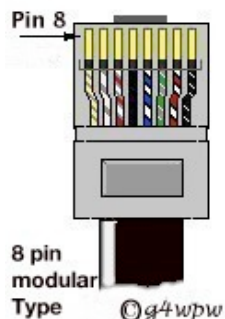

YAESU-FT736-FT747GX-FT757GX-FT650-FT655-FT840-FT890-FT900-FT920-FT990-FT990D-FT847 FT1000-FT1000D-FT1000MP + MKV

PIN1	MIC UP
PIN2	EARTH (+ 5VOLTS FT847-FT920-FT1000MP)
PIN3	DOWN

PIN4	FAST SCAN
PIN5	EARTH
PIN6	PTT
PIN7	SCREEN/EARTH
PIN8	MIC

view from front of transceivers

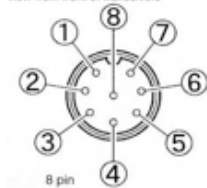

YAESUFTONE-FT77-FT102-FT707-FT767-FT767GX-FT980

PIN1	MIC UP
PIN2	+ 5 VOLTS
PIN3	DOWN
PIN4	FAST SCAN
PIN5	CAUTION INTERCONNECTED TO PIN 2. (+5 VOLTS)
PIN6	PTT
PIN7	SCREEN/EARTH
PIN8	MIC

view from front of transceivers

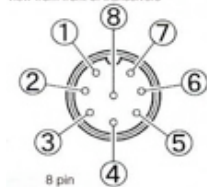

YAESU FT480R-FT780R (see YM-40 above)

PIN1 green	MIC UP
PIN2 yellow	EARTH / COMMON U/DOWN.
PIN3 blue	DOWN
PIN4 brown	tone CALL / LOCK
PIN5 orange	EARTH TONE CALL / LOCK
PIN6 red	PTT
PIN7 black	SCREEN/EARTH
PIN8 white	MIC

view from front of transceivers

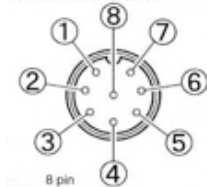

YAESU-FT726 (see MD1-B8 MH1-B8 Microphone above)

PIN1	UP
PIN2	COMMON UP/DOWN
PIN3	DOWN
PIN4	FAST SCAN
PIN5	EARTH
PIN6	PTT
PIN7	SCREEN/EARTH
PIN8	MIC

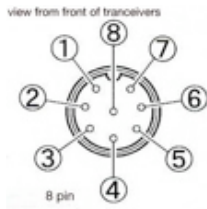

YAESU CPU2500R-CPU2500RK SOMMERKAMP FT227

PIN1	UP
PIN2	COMMON UP/DOWN
PIN3	DOWN
PIN4	PTT
PIN5	GROUND MIC/PTT
PIN6	MIC

[click for schematic](#)



YAESU FT75-FT221R-FT223-FT101B-FT101E-FT101Z-FT101ZD-FT301D-FT902-FT902DM. ([see YD148/YD844 microphone above.](#))

PIN1	MIC SCREEN/EARTH (PTT EARTH ON FT101B/101E.FT101Z/101ZD.FT902/902DM.)
PIN2	MIC
PIN3	PTT
PIN4	EARTH ON FT221R.(N/C ON FT101Z/101ZD.FT101B/101E.FT902/902DM.)



YAESU FTDX-100 FTDX-400 FTDX-401 FTDX-560 FT-200 FT-250([See YD-148 microphone above.](#))

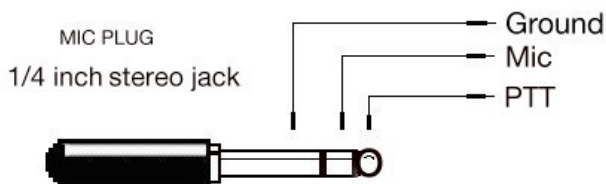

YAESU FT201-FT125C-FTC212-FT2B-FT300C-FT224-FT225RD-FT2FB-FT223-FT220-FTC212-FT300C FT301. FT7-FT227R-FT227RA-FT227RX-FT250-FT401B-FT501-FT625-FL101.

([See YD-148 microphone above.](#))

YAESU-FT950

PIN1	MIC UP
PIN2	+ 5 VOLTS
PIN3	DOWN
PIN4	FAST SCAN
PIN5	GROUND
PIN6	PTT
PIN7	SCREEN/EARTH
PIN8	MIC

view from front of transceivers

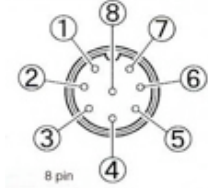
**YAESU FT840-FT990.**

PIN1	UP
PIN2	GROUND
PIN3	DOWN
PIN4	FAST
PIN5	GROUND (INTERCONNECTED ON TRANCEIVER TO PIN 2.)
PIN6	PTT
PIN7	MIC GROUND/SCREEN
PIN8	MIC

view from front of transceivers

**YAESU FT2200.**

PIN1	UP
PIN2	+ 5 VOLTS
PIN3	DOWN
PIN4	SPEAKER.
PIN5	ACC.
PIN6	PTT
PIN7	MIC GROUND/SCREEN
PIN8	MIC

view from front of transceivers

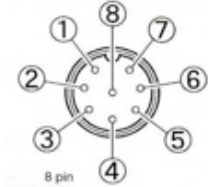
**YAESU FT2500.****8 Pin round plug.**

PIN1	CALL BUTTON.
PIN2	RX AUDIO.
PIN3	PTT.
PIN4	MIC.
PIN5	GROUND.
PIN6	+ 5 VOLTS
PIN7	UP.
PIN8	DOWN.

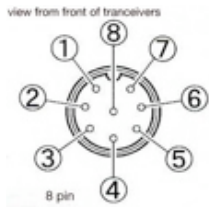

YAESU FT2400H.

PIN1	CALL BUTTON.
PIN2	RX AUDIO.
PIN3	PTT.
PIN4	MIC.
PIN5	GROUND.
PIN6	+ 5 VOLTS
PIN7	UP.
PIN8	DOWN.

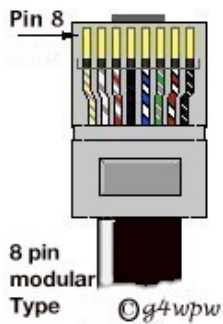

YAESU FT5100.

PIN1	UP.
PIN2	+ 5 VOLTS.
PIN3	DOWN.
PIN4	SPEAKER.
PIN5	BAND.
PIN6	PTT.
PIN7	EARTH.
PIN8	MIC.

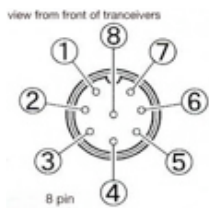

YAESU FT211-FT212R-FT270-FT211RH-FT711-FT712-FT770-FT2311-FT2700-FT4700RH-FT711RH-FT770RH (see MH-15D8/C8 above)

PIN1	UP
PIN2	+5 VOLT
PIN3	DOWN
PIN4	SPEAKER
PIN5	CPU/ TONE SW
PIN6	PTT
PIN7	GROUND
PIN8	MIC

view from front of transceivers

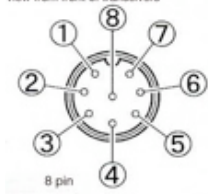

YAESU FT230R-FT290R-FT690 FT730-FT790R

PIN1	MIC SCREEN/EARTH
PIN2	MIC
PIN3	PTT
PIN4	+ 12VOLT (+ 5 VOLTS FT730-FT290R)
PIN5	SPEAKER
PIN6	UP
PIN7	DOWN

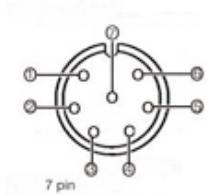

YAESU FT290RII-FT690RII-FT790RII (see [MH-10E8](#) /[MH-10F8](#) above)

PIN1	UP
PIN2	+ 5 VOLTS
PIN3	DOWN
PIN4	SPEAKER
PIN5	N/C
PIN6	PTT
PIN7	GROUND
PIN8	MIC

view from front of transceivers

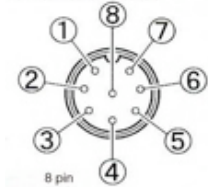

YAESU FT215-FT715-FT3700-FT3800-FT3900-FT4600-FT4800-FT4900-FT5800

PIN1	UP
PIN2	+ 5 VOLTS
PIN3	DOWN
PIN4	N/C
PIN5	RECALL
PIN6	RESET
PIN7	GROUND
PIN8	MIC

view from front of transceivers

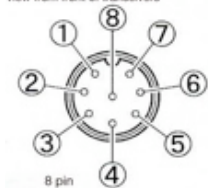

**YAESU FT708R-FT208R HAND HELD.
MINATURE 6 PIN**

PIN1	MIC (white)
PIN2	SPEAKER (black)
PIN3	PTT (red)
PIN4	MIC SCREEN
PIN5	NC
PIN6	SPEAKER (blue)

YAESU-FT897-FT857-FT817-FT900-FT-450-FT2000 (8 pin Modular Plug)

PIN1	FAST SCAN
PIN2	GROUND
PIN3	PTT
PIN4	MIC
PIN5	MIC GROUND
PIN6	+ 5VOLT
PIN7	UP
PIN8	DOWN

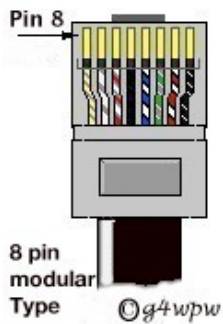

YAESU-FT1500-FT1802E-FT2800-FT7800M-FT8800E-FT8900R (6 Pin modular Plug)(See [MH-48 microphone above](#))

PIN1	SW2
PIN2	SW1
PIN3	+ 8VOLT
PIN4	GROUND
PIN5	MIC
PIN6	PTT (clone FT1802E)

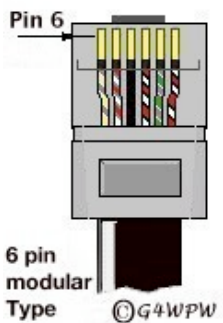

YAESU-FTM-10R/E (WITH BUILT IN MICROPHONE AND BLUE TOOTH.)

NEEDS MEK-M10 ADAPTER TO USE THE FOLLOWING EXTERNAL MICROPHONES

MH-68 A6J WATERPROOF MIC
 MH-68 B6J WATERPROOF MIC

YAESU-FTDX9000D (3 pin XLR Plug front panel) PLUS (8 pin Plug rear panel.)

(XLR PLUG FRONT PANEL.)

PIN1	MIC GRND.
PIN2	MIC HOT.
PIN3	MIC COLD.

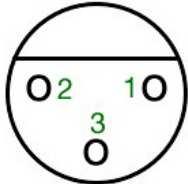

3 pin XLR

(8 PIN PLUG REAR PANEL.)

PIN1	UP.
PIN2	+5 VOLTS.
PIN3	DOWN.
PIN4	FAST SCAN.
PIN5	GROUND.
PIN6	PTT.
PIN7	MIC GROUND.
PIN8	MIC.

view from front of transceivers



8 pin

YAESU-FT100-FT90-FT8100 (6 pin Modular Plug) (SEE MH-36 microphone above.)

PIN1	Multi-function switching for P,P1,P2 SW2.
PIN2	N.C. 9600bps packet data out FT90
PIN3	+ 9VOLT
PIN4	EARTH
PIN5	MIC.
PIN6	SW1.PTT,UP,DOWN,Acc

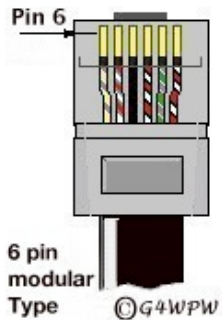

Connector Pinouts

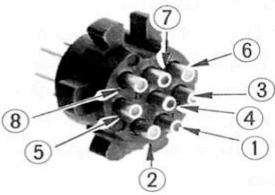
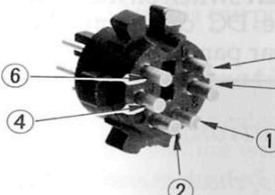
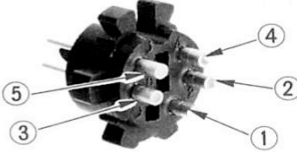
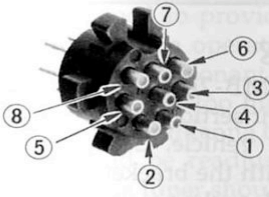
BAND DATA	CAT
 <ol style="list-style-type: none"> 1. +13.5 V 2. TX GND 3. GND 4. BAND DATA A 5. BAND DATA B 6. BAND DATA C 7. BAND DATA D 8. LINEAR 	 <ol style="list-style-type: none"> 1. GND 2. SERIAL OUT 3. SERIAL IN 4. PTT 5. S/PO 6. NC
TUNER 1 (used w / FC-800)	TUNER 2 (used w / FC-10)
 <ol style="list-style-type: none"> 1. GND 2. +13.5V 3. DATA 4. GND 5. GND BY FC-800 	 <ol style="list-style-type: none"> 1. +13.5V 2. TX GND 3. GND 4. DATA IN 5. DATA OUT 6. TUNER SENSE 7. RESET 8. TX INH

Yaesu "cat" pinout connections.

ICOM.

ICOM-IC7400-IC746-IC746PRO-IC756PRO-IC7700-IC7800 (see HM-36 below)

PIN1	MIC + DC VOLTS FOR ICOM ONLY MICROPHONE
PIN2	+ 8VOLTS 10Ma TO AVOID DAMAGING THE REGULATOR DO NOT SHORT TO GROUND
PIN3	UP/DOWN
PIN4	SQUELCH
PIN5	PTT
PIN6	GROUND
PIN7	MIC SCREEN/EARTH
PIN8	AUDIO OUT

view from front of transceivers



ICOM-IC703-IC706MK1-IC706MK2-IC706MK3-IC2000-IC2000H (8 Pin Modular Plug)

PIN1	+ 8VOLT
PIN2	UP/DOWN
PIN3	AUDIO OUT
PIN4	PTT
PIN5	MIC GROUND
PIN6	MIC
PIN7	GROUND/EARTH

PIN8

SQUELCH

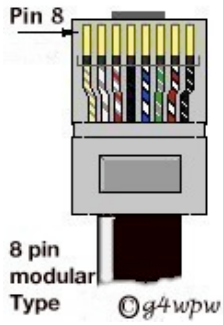

ICOM-ICE-208-IC2100H-IC2200H-IC2725E-IC2820-(See [HM-133](#) below) (8 Pin Modular Plug)

PIN1	+ 8VOLT OUTPUT (10 ma max)
PIN2	UP/DOWN
PIN3	+ 8VOLTS IN (No connection IC2100H)
PIN4	PTT
PIN5	MIC GROUND
PIN6	MIC
PIN7	GROUND/EARTH
PIN8	DATA IN (No connection IC2100H)

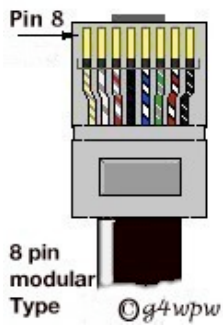

ICOM-IC-7000 (8 Pin Modular Plug)
IMPORTANT! SEE [HM-151](#) MICROPHONE INFO BELOW.

PIN1	+ 8VOLT OUTPUT (10 ma max)
PIN2	UP/DOWN
PIN3	+ 8VOLTS SW
PIN4	PTT
PIN5	MIC GROUND
PIN6	MIC
PIN7	GROUND/EARTH
PIN8	DATA IN

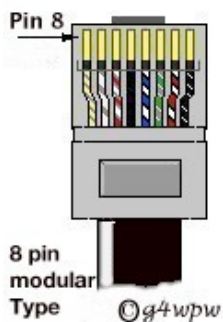

ICOM-IC-2800 (8 Pin Modular Plug) **SEE HM-98 MICROPHONE BELOW.**

PIN1	+ 8VOLT OUTPUT (10 ma max)
PIN2	UP/DOWN
PIN3	+ 8VOLTS SW
PIN4	PTT
PIN5	MIC GROUND
PIN6	MIC
PIN7	GROUND/EARTH
PIN8	DATA IN

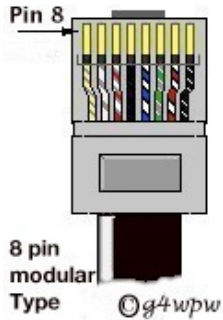

ICOM-IC-202 IC-202S-215-22S-240-245-280-402-502

PIN1	MIC (yellow)
PIN2	PTT (red)
external speaker plug (green)	
PIN4	GROUND. (black)



ICOM HAND HELD- ICE90- IC91A/E- ICE7- ICT2A/E/H-ICT3H ICT7A/E/H- ICT21A/E -ICT22 -ICT41E- ICT81A/E- ICV8- ICV21AT- ICV82 ICV82- ICT90- ICF3

(**SEE HM-46 HM75A HM-131 BELOW**)

ICOM HAND HELD- IC4A/AT/E-IC3A/AT-IC12A/AT/E

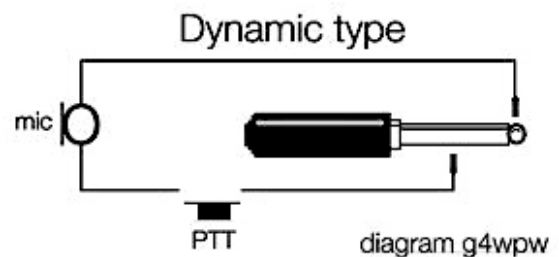
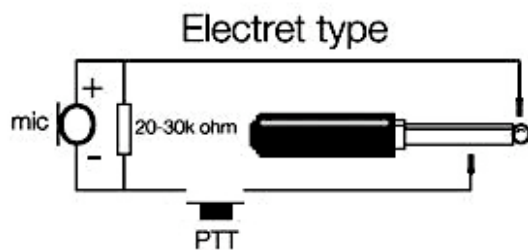

ICOM HAND HELD- ICT8A- ICT8E

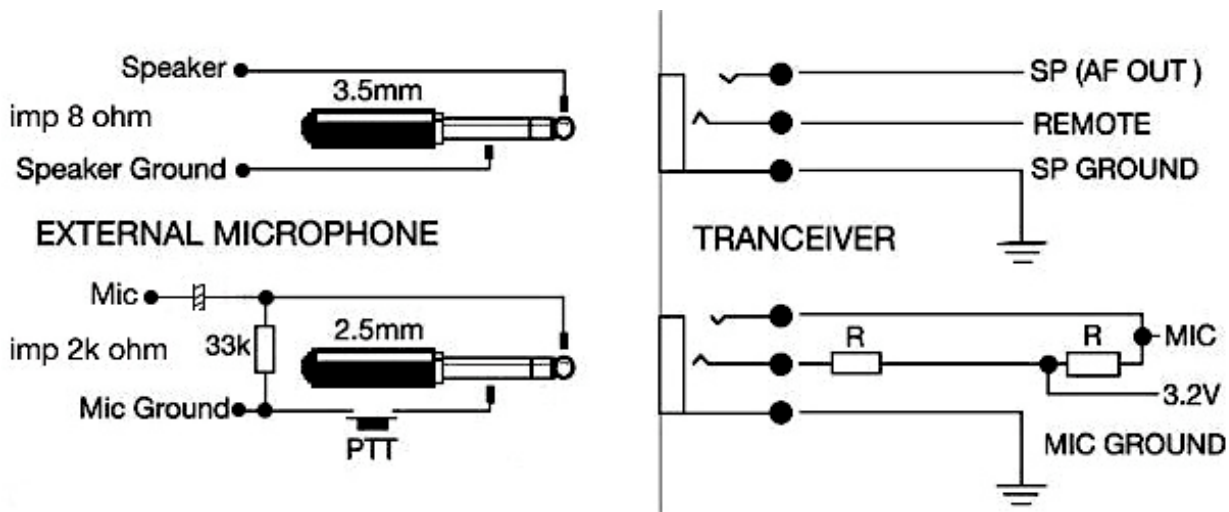

ICOM-IC-211

PIN1	MIC
PIN2	PTT
PIN3	N/C
PIN4	GROUND.



ICOM IC-120-271A-271E-275-290-228-229-229H-22U-25-25E-27-27E-28-29E-255-260-290-2400-2500-3200-3210-3220
 IC-37A-38A-375-45-47-77-78-451-471A-475-48-490-505-551-560-575-707-718-720-725-726-728-729-730-735-736-737/A
 IC-740-745-746-751/A-756/PRO-761-765-775-781-820H-821-821H-900-901-901H-910X-970-1200-1201-1271-1275

PIN1	MIC (yellow)
PIN2	REPEATER TONE (+ 8/9 volts some models)
PIN3	UP/DOWN
PIN4	N/C (squelch some models)
PIN5	PTT(red)
PIN6	EARTH (black)
PIN7	MIC SCREEN
PIN8	N/C (green)(external speaker some models)

(For IC-27 / 27E see IC-HM24 below)

view from front of transceivers



ICOM-IC24G-IC251E-IC451E. (See SM-5 hand mic & SM-5 desc mic.)

PIN1	MIC (white. connection at + 9VOLTS above earth)
PIN2	NC
PIN3	NC
PIN4	NC

PIN5	PTT (red)
PIN6	PTT (black)
PIN7	MIC SCREEN
PIN8	NC

view from front of transceivers

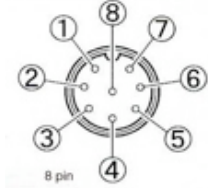
**CAUTION !**

IF YOU WISH TO USE THE FOLLOWING ICOM MICROPHONE'S (model's below) ON
 TRANCEIVERS OTHER THAN ICOM, CHECK THIS [link](#) INFORMATION ALSO

Modification to enable Icom microphone's to be used on non Icom Tranceivers

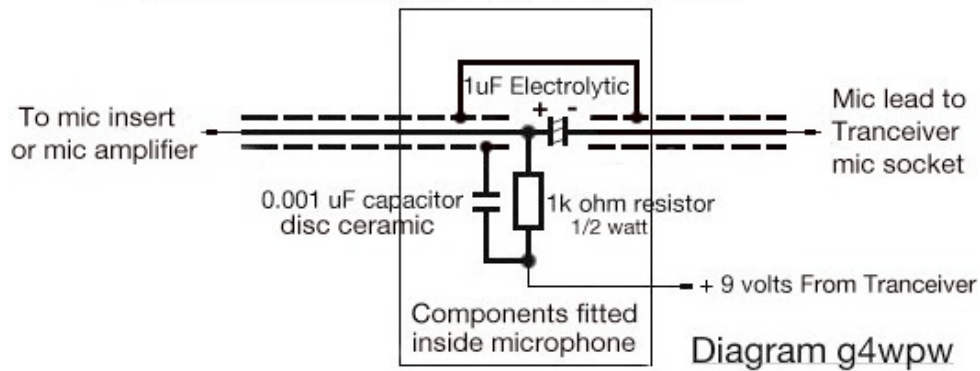
**MICROPHONE MODEL'S**

IC-SM8 IC-SM6 IC-HM7 IC-HM11 IC-HM12 IC-HM14 IC-HM15 IC-HM22 IC-HM24 IC-HM36

ALINCO.

PIN 1 MIC (yellow)
 PIN 2 PTT (orange)
 PIN 3 DWN (white)
 PIN 4 UP (green)
 PIN 5 +5v (red) max current 25mA
 PIN 6 (purple) see notes:
 PIN 7 MIC GND (black/shield)
 PIN 8 GND (grey)
 note:
 PIN 6 info:
 DR-590/592/599/600=bus line for remote commands from mic
 DR-110/112/570=no connection
 DR-130=pc programing bus

view from cable side of plug

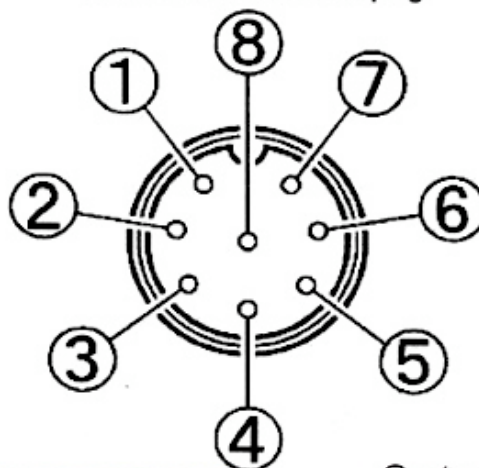

ALINCO MOBILE RADIO'S

© g4wpw

ALINCO DX70-DX70T-DX77-DR135-DR435-DR150E-DR150TE-DR430-DR510-DR570-DR590-DR592T-DR599T-DR600T-DR610

ALR22H-ALD24T-ALR22T-ALR72T-DR110-DR112-DR-M03-DR-M06

PIN1	MIC
PIN2	PTT
PIN3	DOWN
PIN4	UP
PIN5	+ 5VOLT (Max current 25Ma)
PIN6	AUDIO OUT (remote DR150TE-DR590-DR592-DR599-DR600) SEE ABOVE DIAGRAM REFERENCE.
PIN7	MIC SCREEN/EARTH
PIN8	EARTH

view from front of transceivers

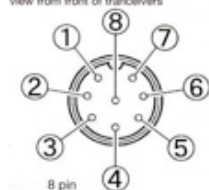

ALINCO DR140-DR605 (Modular Plug)

PIN1	UP.
PIN2	GROUND.
PIN3	MIC.
PIN4	MIC GROUND.
PIN5	PTT.
PIN6	N/C.
PIN7	DOWN.
PIN8	+ 5 VOLTS.

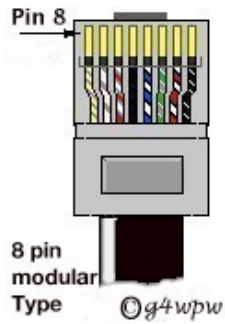

ALINCO 22T/E.24E/T

PIN1	MIC
PIN2	PTT
PIN3	DOWN
PIN4	UP
PIN5	+ 8VOLT
PIN6	N/C
PIN7	MIC EARTH
PIN8	GROUND

view from front of transceivers

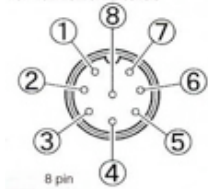

ALINCO EMS-14. - ADONIS AM-508E. -WATSON AM308 MICROPHONE COLOR CODING.

YELLOW	MIC
SCREEN	EARTH (ground)
GREY	PTT (+ VOLTAGE FEED ON ADONIS D80)
BLUE	PTT EARTH ON WATSON 308.
PURPLE	PTT EARTH (ground)
GREEN	MIC UP
ORANGE	COMMON (connect to ground)
WHITE	MIC DOWN (+ VOLTS WATSON AM-308)
BLACK	MIC DOWN ON WATSON AM-308
RED	+ VOLTS FEED(PTT ON ADONIS D80 AND WATSON AM-308)

ALINCO DMR610 DR-135 DR-435.

PIN 1	MIC
PIN 2	PTT
PIN 3	DOWN
PIN 4	UP
PIN 5	+5 VOLTS
PIN 6	REMOTE CONTROL
PIN 7	SCREEN EARTH (ground)
PIN 8	GND

view from front of transceivers



ALINCO. DJ-S11 DJ-41 DJ-180 DJ-190 DJ-191 DJ-491G DJ-G1 DJ-G5

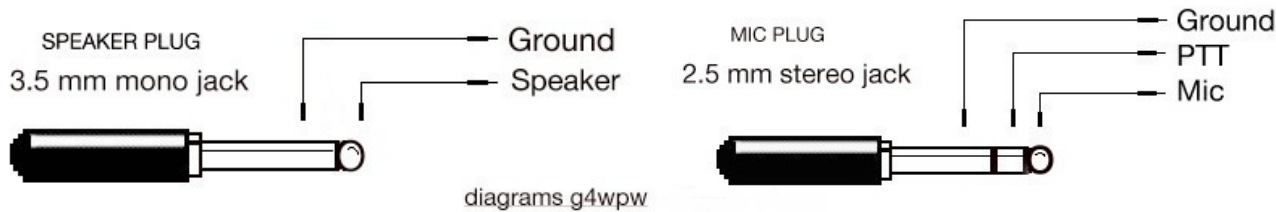

ALINCO. DJ-560 DJ-580

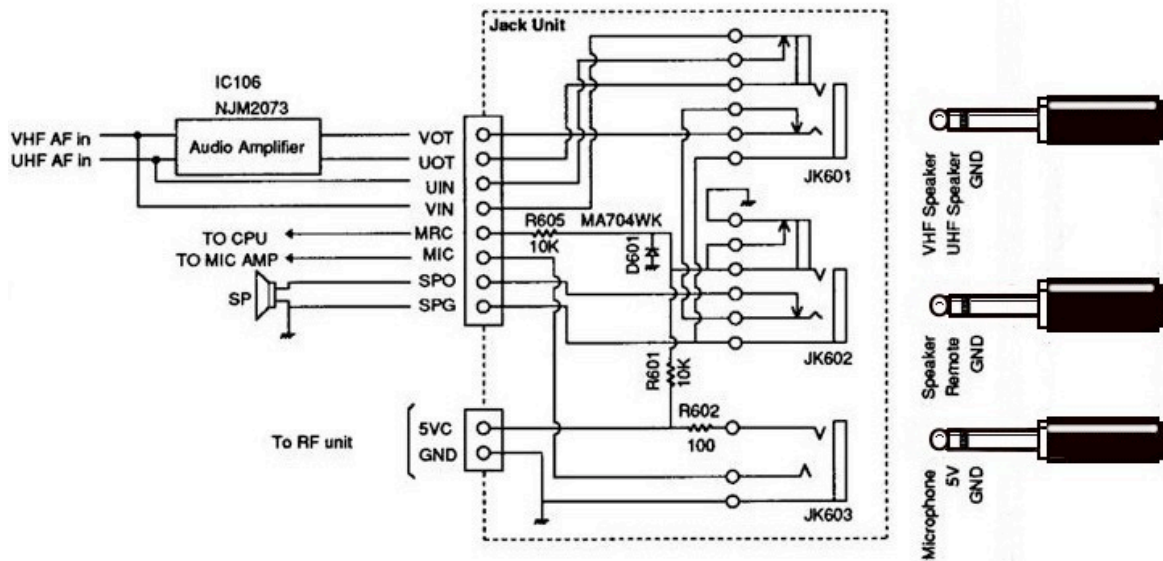

ADONIS MICROPHONE CONVERSION LEADS FOR AM-708 ABOVE.

ADONIS LEAD NUMBER D-88K AS-327 (Connections for Kenwood configuration)

SILVER PLUG END (tranceiver).	ORANGE PLUG END (connected to microphone).
PIN 1 YELLOW. connected to	PIN 2.YELLOW.(mic)
PIN 2 RED. ..	PIN 3.RED.(ptt)
PIN 3 WHITE. ..	PIN 6.WHITE.(down)
PIN 4 GREEN. ..	PIN 5.GREEN.(up)
PIN 5 GREY. ..	PIN 8.GREY.(+volts DC feed)
PIN 6 N/C. ..	PIN 4.PURPLE.(ptt ground)
PIN 7 SCREEN. ..	PIN 1.SCREEN.(mic ground)
PIN 8 ORANGE+PURPLE. ..	PIN 7.ORANGE.(up/down common ground)

ADONIS LEAD NUMBER D-80K AS-340

This is sold as a spare lead with only orange (mic end) plug fitted.

- ORANGE PLUG END (connected to microphone).
- PIN 2.YELLOW.(mic)
 - PIN 3.RED.(ptt)
 - PIN 6.WHITE.(down)
 - PIN 5.GREEN.(up)
 - PIN 8.GREY.(+volts DC feed)

PIN 4.PURPLE.(ptt ground)
 PIN 1.SCREEN.(mic ground)
 PIN 7.ORANGE.(up/down common ground)

COLOURS AND CONNECTIONS ON THE ORANGE (mic) PLUG ENDS OF LEADS ARE IDENTICAL.

view from front of transceivers



STANDARD ADONIS MICROPHONE COLOR CODING

YELLOW. (mic)
 RED. (ptt)
 WHITE. (down)
 GREEN. (up)
 GREY. (+volts DC feed)
 PURPLE. (ptt ground)
 SCREEN. (mic ground)
 ORANGE. (up/down common ground)

ADI.

ADI. AR-146 AR-446

8 PIN ROUND PLUG.

PIN 1	MIC.
PIN 2	PTT.
PIN 3	DOWN.
PIN 4	UP.
PIN 5	+ 8VOLTS (max 150 Ma).
PIN 6	RX AUDIO OUT.
PIN 7	MIC SCREEN.
PIN 8	GROUND.

view from front of transceivers



ATLAS.

ATLAS TRANCEIVERS MODELS.-TX110-180-210-215-350XL.
ATLAS-VX5 VOX UNIT.

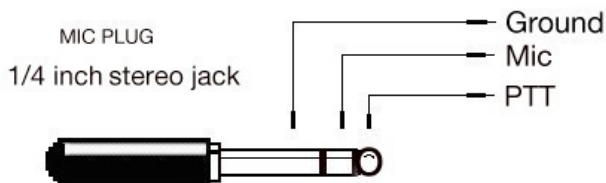

AZDEN.

PCS-5000-6000-7000

PIN 1	MIC.
PIN 2	MIC GROUND.
PIN 3	-
PIN 4	DOWN.
PIN 5	UP.
PIN 6	COMMON GROUND.
PIN 7	PTT.
PIN 8	+13.8 VOLTS

view from front of transceivers

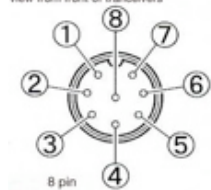

COLLINS.

KMW-1 KWM-2 KWS-1 KWM-2A KWM-380 KWM-390 (S-LINE) 32S-1 32V-2 32S-3 .

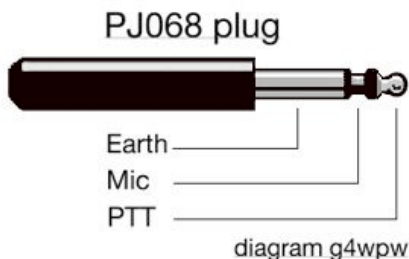

DRAKE.

DRAKE. TR-5 TR-7 TR-7A

4 PIN PLUG.

PIN 1 MIC.
 PIN 2 PTT.
 PIN 3/4 EARTH/GROUND.



DRAKE. TR-3 TR-4 TR-4B TR-4C T-4XC T-4XB

(S230 Mic Plug.)

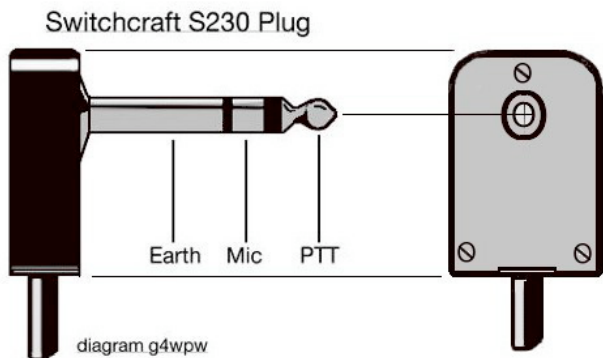

FDK.

FDK. MULTI-UII MULTI-II MULTI-700E MULTI-700EX MULTI-750E MULTI-800D MULTI-2700 MULTI-2700-MKII MULTI-3000 QUARTZ-16

4 PIN ROUND PLUG.

PIN 1/4 GROUND / MIC SREEN
 PIN 2 PTT.
 PIN 3 MIC.



HALLICRAFTER.

HALLICRAFTER. HT-46

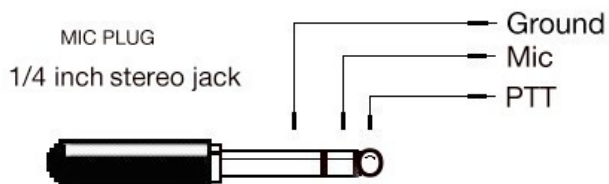

HALLICRAFTER. HT-36 HT-44 SR-42 SR-42A SR-46 SR-150 SR-160 SR-400 SR-400A SR-500 SR-540 SR-2000

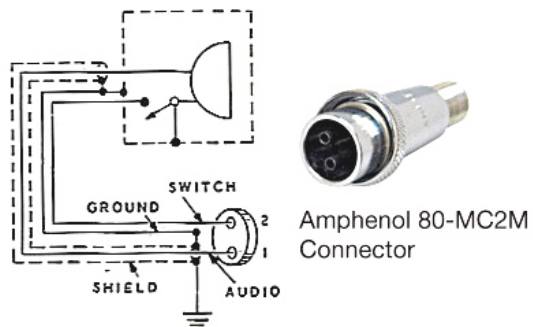

HALLICRAFTER. HT-40 HT-37



HEIL.

HM-10 DUAL, GM-4,GM-5,GMV. HANDIMIC-HM-4, HM-5, HM-iC, HM-PRO. CLASSIC. 4 PIN XLR PLUG.

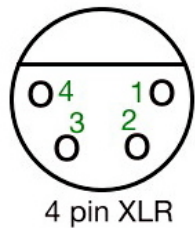

- PIN 1 GROUND / SHIELD.
- PIN 2 MIC.
- PIN 3/4 PTT.

PRO-20, PRO-30, PR0-40, CLASSIC PRO, HERITAGE. 3 PIN XLR PLUG.

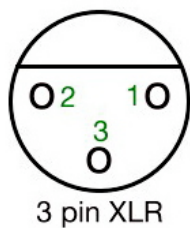

UNBALANCED OUTPUT.

PIN 1 SHIELD.
 PIN 2 + MIC.
 PIN 3 - MIC.(connected to pin 1)

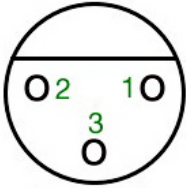

3 pin XLR

BALANCED OUTPUT.

PIN 1 SHIELD.
 PIN 2 + MIC OUTPUT
 PIN 3 - MIC GROUND

JRC.**JST-135 JST-145 JST-245.**

PIN1 MIC UP
 PIN2 NC
 PIN3 MIC DOWN
 PIN4 + 9 VOLTS
 PIN5 PTT EARTH
 PIN6 PTT
 PIN7 MIC EARTH
 PIN8 MIC

view from front of transceivers

**KDK.****KDK. FM-2016 FM-2025****4 PIN ROUND PLUG.**

PIN 1 PTT GROUND.
 PIN 2 PTT.
 PIN 3 MIC SCREEN.
 PIN 4 MIC.



KDK. FM-2030 FM-2033

6 PIN ROUND PLUG.

PIN 1	UP/DOWN GROUND.
PIN 2	UP.
PIN 3	DOWN.
PIN 4	PTT.
PIN 5	MIC.
PIN 6	MIC SREEN/GROUND.

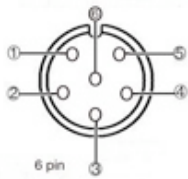

KW.

KW TRANSMITTERS /TRANCEIVERS KW-1 KW-2000 KW-2000A KW-2000B KW-VESPA KW-VICEROY

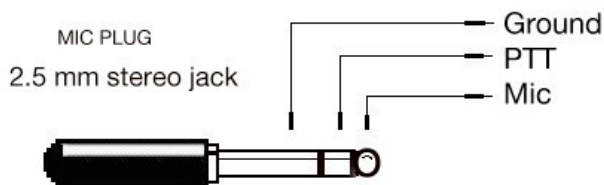

MFJ.

MFJ-8621. DATA CONNECTIONS. Must be configured for 1200 baud operation.

Note:This radio has un-squelched output.use "software DCD"

PIN1	AFSK In (yellow)
PIN2	GROUND/EARTH (black)
PIN3	PTT (red)
PIN4	AFSK Out (green)

MFJ-297 MF-J299 MICROPHONES.

PIN1	MIC GROUND
PIN2	MIC
PIN3	PTT
PIN4	PTT GROUND

PIN5 UP
 PIN6 DOWN
 PIN7 COMMON UP/DOWN
 PIN8 DC VOLTS.

view from front of transceivers

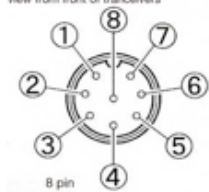

NAVICO.

AMR-1000/S.

PIN1 MIC GROUND 0VOLTS
 PIN2 PHONES
 PIN3 CRADLE
 PIN4 PTT
 PIN5 MIC
 PIN6 +12 VOLTS
 PIN7 DOWN
 PIN8 UP

view from front of transceivers

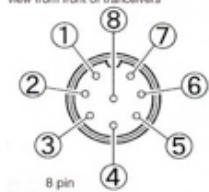

RADIO SHACK.

RADIO SHACK. (Modular Connector)

Models HTX-212.HTX242.

PIN2 GROUND/EARTH (black)
 green EXTERNAL SPEAKER
 PIN5 MIC (yellow)
 PIN6 PTT (red)

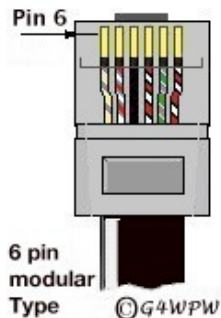

SGC.

SG-2020.

PIN 1	MIC.
PIN 2	PTT.
PIN 3	OPT 1.
PIN 4	OPT 2.
PIN 5	N/C.
PIN 6	RX AUDIO OUT.
PIN 7	MIC GROUND.
PIN 8	GROUND.

view from front of transceivers

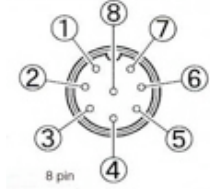

SOMMERKAMP

TS-280FM TS-480FM.

ACCESSORY JACK

The 8-pin DIN standard accessory jack has the following internal connections:

1. Microphone input (Z600-10K ohm)
2. Transmit/Receive switching
3. Ground (SP)
4. Audio output. (Z8-10K ohm)
5. Internal speaker.
6. +12V for VOX unit etc.
7. AF out for selective call.
8. EXT. Squelch.
Case = ground

Always operate the transceiver with the microphone plug inserted in the microphone jack, or with the following external connections:

1. Microphone with VOX.

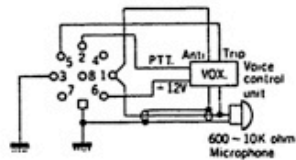

5. External microphone/Speaker with PTT.

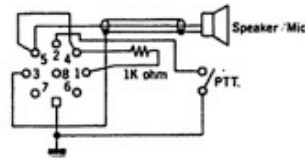

2. Headset or Telephoneset with PTT.

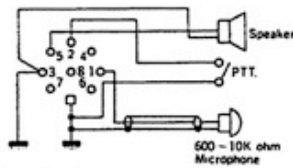

6. Internal connection

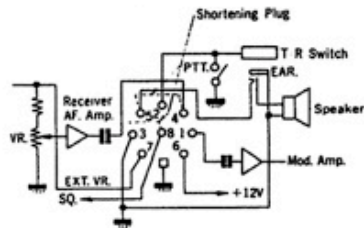

3. External microphone

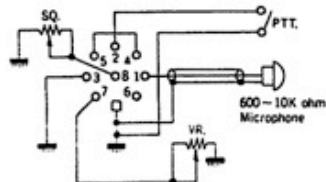

7. Internal connection with SP. selection switch

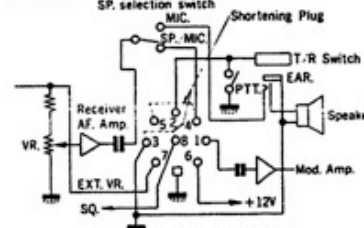

4. Headset or Telephoneset with VOX.

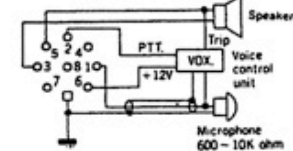

8. Parrot 76

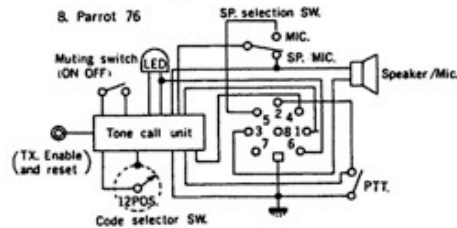

SOMERKAMP

FT-307CBM (see YAESU FT-107)

FT-277ZD (see YAESU FT-101ZD)

FT-767DX (see YAESU FT-707)

FT-7B (see YAESU FT-7)

STANDARD.

C58-C78-C88-C1100-C4100-C5800-C7800-C8800-C8900

PIN 1	MIC.
PIN 2	PTT.
PIN 3	SPEAKER.
PIN 4	COMMON (NOTE:+8VOLTS ON THIS CONNECTION.)

PIN 5 DOWN.
 PIN 6 UP.
 PIN 7 GROUND.

Note.0.001uF capacitor is connected between pin 1 and pin 7

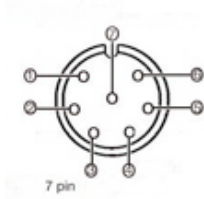

STANDARD.
C5000-C5200-C6000-C6000S

PIN 1 MIC.
 PIN 2 PTT.
 PIN 3 SPEAKER.
 PIN 4 COMMON.
 PIN 5 UP.
 PIN 6 DOWN.
 PIN 7 CALL.
 PIN 8 GROUND.

view from front of transceivers

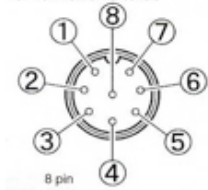

STANDARD.
C5900 (8 pin modular type plug.)

PIN 1
 PIN 2
 PIN 3
 PIN 4 PTT.
 PIN 5 GROUND.
 PIN 6 MIC.
 PIN 7
 PIN 8

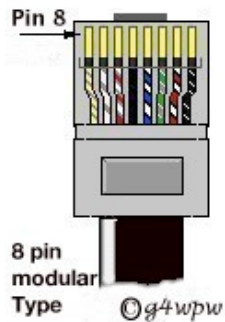

SWAN.

SWAN.100MX- SS-200A-250C-350-400-500-500C-700CX-750.

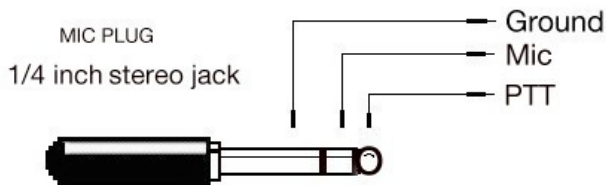

TEN TEC.

TEN-TEC ORION - ARGONAUT - JUPITER - OMNI VI - PARAGON - DELTA II - CORSAIR - SCOUT-555
4 PIN PLUG.

PIN1	MIC +
PIN2	MIC -
PIN3	PTT
PIN4	+9 VOLTS.
SHELL/CHASSIS=GROUND	



TEN-TEC ORION II / OMNI VII.
8 PIN PLUG.

PIN1	N/C
PIN2	+10 VOLTS
PIN3	N/C
PIN4	N/C
PIN5	GROUND
PIN6	PTT
PIN7	MIC EARTH
PIN8	MIC

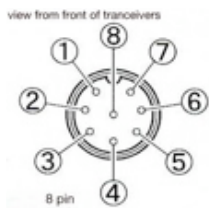

SEE MAIN PAGE FOR MORE INFORMATION AND MICROPHONE LISTS